

Aesculap® Veterinärosteosynthese

Implantate, Instrumente und Setkonfiguration



Aesculap® Veterinärosteosynthese

Knochenschrauben

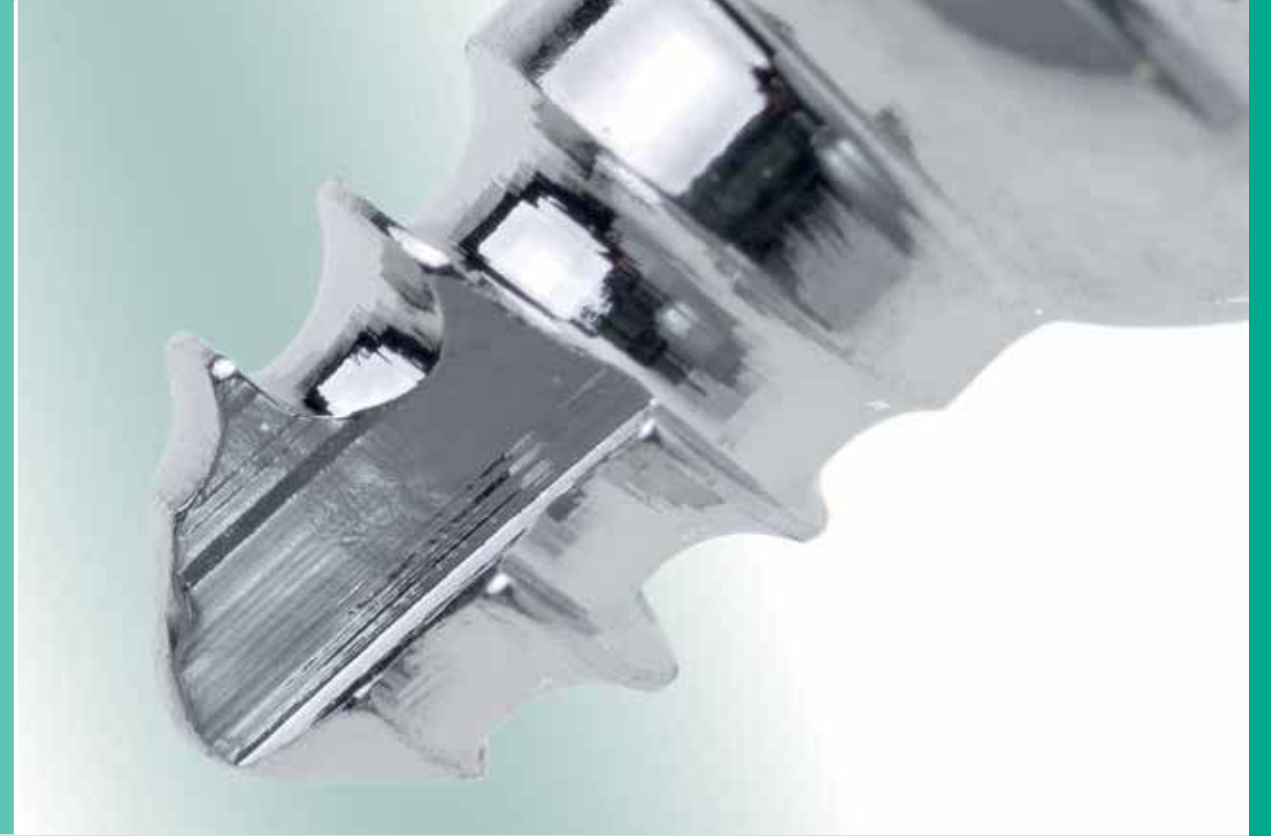

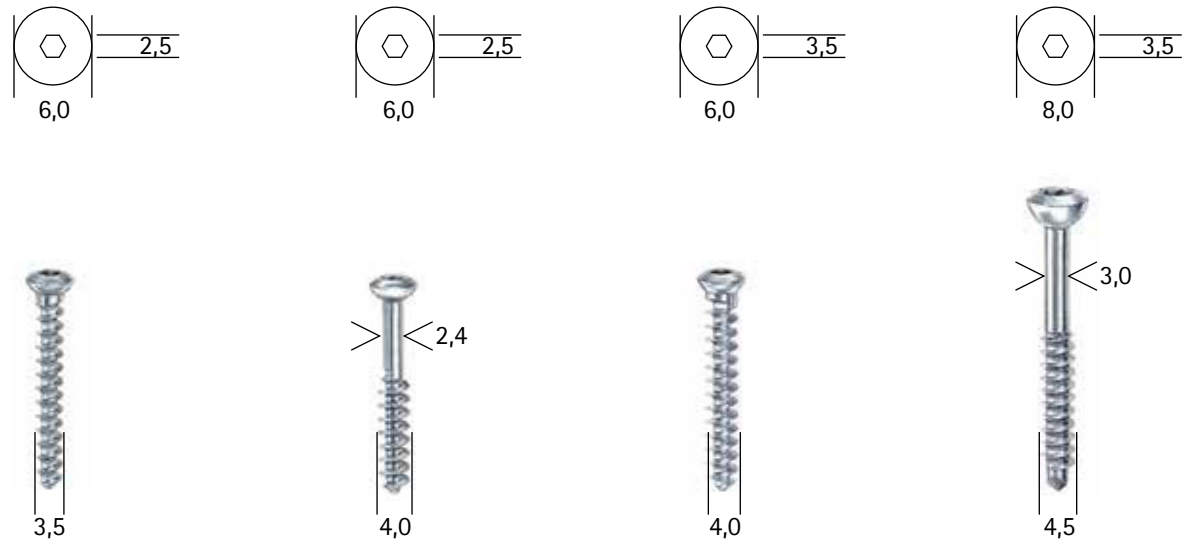

Spongiaschraube 3,5 mm

Kerndurchmesser 1,9 mm
 Gewindedurchmesser 3,5 mm
 Innensechskant 2,5 mm
 Kopfdurchmesser 6,0 mm
 Gewindesteigung 1,75 mm

Länge mm	standard
10	LB050S
12	LB052S
14	LB054S
16	LB056S
17	LB057S
18	LB058S
19	LB059S
20	LB060S
21	LB061S
22	LB062S
23	LB063S
24	LB064S
25	LB065S
26	LB066S
27	LB067S
28	LB068S
30	LB070S
32	LB072S
36	LB076S
40	LB080S

Spongiaschraube Teilgewinde | 4,0 mm

Kerndurchmesser 1,9 mm
 Gewindedurchmesser 4,0 mm
 Innensechskant 2,5 mm
 Kopfdurchmesser 6,0 mm
 Gewindesteigung 1,75 mm

Länge mm	standard
10	LB250S
12	LB252S
14	LB254S
16	LB256S
18	LB258S
20	LB260S
22	LB262S
24	LB264S
26	LB266S
28	LB268S
30	LB270S
35	LB275S
40	LB280S
45	LB285S
50	LB290S
55	LB295S
60	LB300S

Spongiaschraube 4,0 mm

Kerndurchmesser 1,9 mm
 Gewindedurchmesser 4,0 mm
 Innensechskant 3,5 mm
 Kopfdurchmesser 6,0 mm
 Gewindesteigung 1,75 mm

Länge mm	standard
10	LB350S
12	LB352S
14	LB354S
16	LB356S
18	LB358S
20	LB360S
22	LB362S
24	LB364S
26	LB366S
28	LB368S
30	LB370S
32	LB372S
35	LB375S
40	LB380S
45	LB385S
50	LB390S
55	LB395S
60	LB400S

Malleolarschraube 4,5 mm

Kerndurchmesser 3,0 mm
 Gewindedurchmesser 4,5 mm
 Innensechskant 3,5 mm
 Kopfdurchmesser 8,0 mm
 Gewindesteigung 1,75 mm

Länge mm	standard
20	LA220S
25	LA225S
30	LA230S
35	LA235S
40	LA240S
45	LA245S
50	LA250S
55	LA255S
60	LA260S
65	LA265S
70	LA270S
80	LA280S

Unterlegscheiben

LA195S Ø 7,0 mm		LA197S Ø 11,0 mm	
-------------------	--	--------------------	--

	Schaft	Minifragment Schraube corticalis		Kleinfragment Schraube corticalis			Großfragment Schraube corticalis		Kleinfragment Schraube spongiosa	
		1,5	2,0	2,4	2,7	3,5	4,5	4,5 malleolar	3,5	4,0
		1,1	1,5	1,8	2,0	2,5	3,2		2,0	
Kernbohrer	Dental	GC461R GC481R	GC462R GC482R		GC464R GC484R				GC464R	
	AO	VC030R	VC031R	VC032R	VC033R	VC035R	GC319R		VC033R	
	Rund		GC002R		GC004R	GC006R	GC009R		GC004R	
		1,5	2,0	2,4	2,7	3,5	4,5		3,5	4,0
Durchgangsbohrer	Dental	GC462R GC482R	GC464R GC484R							
	AO	VC031R	VC033R	VC034R	VC036R	VC037R	GC323R		VC037R	
	Rund	GC002R	GC004R		GC007R	GC010R	GC013R		GC010R	GC012R
		1,5	2,0	2,4	2,7	3,5	4,5		3,5	4,0
Gewinde-schneider	Dental	GC437R	GC438R							
	AO	VC040R	VC041R	VC042R	VC043R	VC044R	GC344R		GC340R	GC346R
	4 Kant								GC440R	
Kopfraum-fräser	Dental	GC431R								
	AO				GC332R		GC335R		GC332R	
		SW 1,5		SW 2,5			SW 3,5		SW 2,5	
Schraubenzieher	mit Griff	LS005R		LS002R			LS001R/LS003R		LS002R	
	Dental	GC458R								
	4 Kant						GC454R			
	AO				GC355R		GC354R		GC355R	
Tiefen-mess-lehre		LS042R		LS044R			LS047R		LS044R	

Aesculap® Veterinärosteosynthese

Knochenplatten



Mini DCP-Platte | 1,5 - 2,0 mm

Platten für Schraubendurchmesser 1,5 mm/2,0 mm
 Plattenbreite 5,0 mm | Abstand zw. d. L. 5,0 mm | Zentraler Steg 5,0 mm

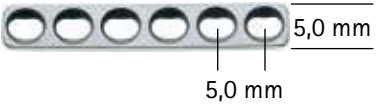
Art-Nr.	Loch	Länge mm	Plattenstärke 1,0 mm
VN144S	4	20	
VN145S	5	25	
VN146S	6	30	
VN147S	7	35	
VN148S	8	40	

Mini DCP-Platte | 2,0 mm

Platten für Schraubendurchmesser 2,0 mm
 Plattenbreite 5,3 mm | Abstand zw. d. L. 5,0 mm | Zentraler Steg 6,0 mm

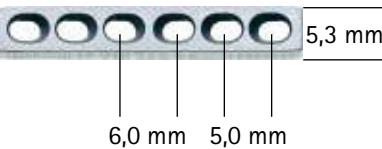
Art-Nr.	Loch	Länge mm	Plattenstärke 2,0 mm
VN154S	4	22	
VN155S	5	27	
VN156S	6	32	
VN157S	7	37	
VN158S	8	42	
VN159S	9	47	
VN160S	10	52	
VN161S	11	57	
VN162S	12	62	
VN163S	13	67	
VN164S	14	72	
VN165S	15	77	
VN166S	16	82	
VN167S	17	87	
VN168S	18	92	

Mini DCP-Platte nach Meyer-Lindenberg | 2,0 mm

Platten für Schraubendurchmesser 2,0 mm
 Plattenbreite 5,2 mm | Abstand zw. d. L. 5,0 mm | Zentraler Steg 12,0 mm

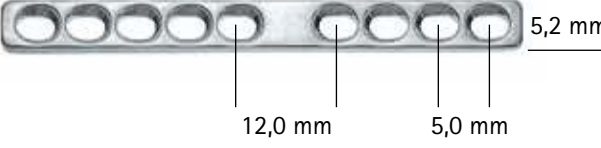
Art-Nr.	Loch	Länge mm	Plattenstärke 2,0 mm
LN939S	9	52	
LN940S	10	58	
LN942S	12	67	
LN944S	14	77	
LN946S	16	87	
LN948S	18	97	

Mini Verlängerungsplatte nach Meyer-Lindenberg | 2,0 mm

Platten für Schraubendurchmesser 2,0 mm
 Plattenbreite 5,2 mm | Abstand zw. d. L. 5,0 mm | Zentraler Steg 25,0 mm - 35,0 mm

Art-Nr.	Loch	Länge mm	Plattenstärke 2,0 mm
LN956S	6	52	
LN957S	7	57	
LN959S	9	67	
LN960S	10	72	
LN962S	12	82	
LN964S	14	92	
LN966S	16	102	
LN968S	18	112	
LN972S	6 + 6	92	
LN973S	6 + 6	102	
LN974S	6 + 6	112	

Kleinfragment DCP-Platte | 2,4 mm

Platten für Schraubendurchmesser 2,4 mm | auch für Schraubendurchmesser 2,0 mm und 2,7 mm geeignet
 Plattenbreite 6,5 mm | Abstand zw. d. L. 7,0 mm | Zentraler Steg 9,0 mm

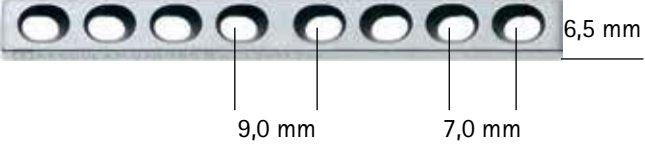
Art-Nr.	Loch	Länge mm	Plattenstärke 2,3 mm
VN174S	4	31	
VN175S	5	38	
VN176S	6	45	
VN177S	7	52	
VN178S	8	59	
VN179S	9	66	
VN180S	10	73	
VN181S	11	80	
VN182S	12	87	
VN183S	13	94	
VN184S	14	101	
VN185S	15	108	
VN186S	16	115	

Kleinfragment DCP-Platte | 2,7 mm

Platten für Schraubendurchmesser 2,7 mm
Plattenbreite 8,0 mm | Abstand zw. d. L. 8,0 mm | Zentraler Steg 10,0 mm

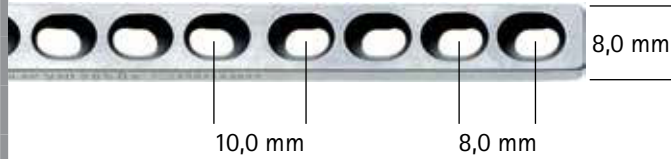
Art-Nr.	Loch	Länge mm	Plattenstärke 2,5 mm
VN194S	4	36	
VN195S	5	44	
VN196S	6	52	
VN197S	7	60	
VN198S	8	68	
VN199S	9	76	
VN200S	10	84	
VN201S	11	92	
VN202S	12	100	
VN203S	13	108	
VN204S	14	116	

Kleinfragment Verlängerungsplatte nach Schuster | 2,7 mm

Platten für Schraubendurchmesser 2,7 mm
Plattenbreite 8,0 mm | Abstand zw. d. L. 8,0 mm

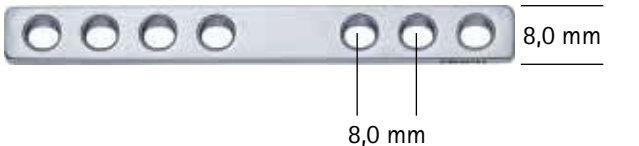
Art-Nr.	Loch	Länge mm	Plattenstärke 2,5 mm
LN975S	7	70	
LN976S	7	80	
LN977S	7	90	
LN980S	8	80	
LN981S	8	90	
LN983S	8	110	
LN984S	8	120	

DCP-Platte | 3,5 mm

Platten für Schraubendurchmesser 3,5 mm
Plattenbreite 10,0 mm | Abstand zw. d. L. 12,0 mm | Zentraler Steg 14,0 mm

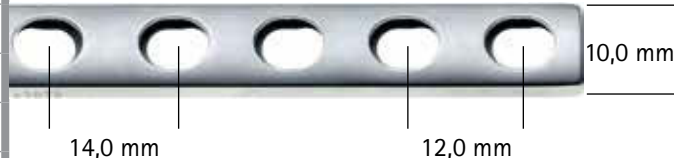
Art-Nr.	Loch	Länge mm	Plattenstärke 3,0 mm
VN214S	4	50	
VN215S	5	62	
VN216S	6	74	
VN217S	7	86	
VN218S	8	98	
VN219S	9	110	
VN220S	10	122	
VN221S	11	134	
VN222S	12	146	
VN224S	14	170	

DCP-Platte verstärkt | 3,5 mm

Platten für Schraubendurchmesser 3,5 mm
Plattenbreite 12,0 mm | Abstand zw. d. L. 12,0 mm | Zentraler Steg 14,0 mm

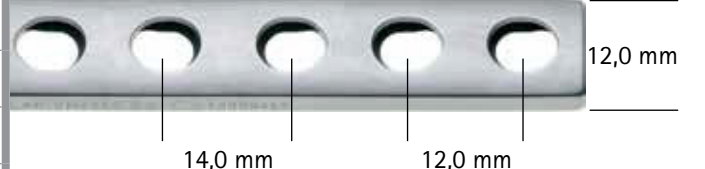
Art-Nr.	Loch	Länge mm	Plattenstärke 4,0 mm
VN236S	6	74	
VN237S	7	86	
VN238S	8	98	
VN239S	9	110	
VN240S	10	122	
VN241S	11	134	
VN242S	12	146	
VN244S	14	170	

Verlängerungsplatte Modell Hannover | 3,5 mm

Platten für Schraubendurchmesser 3,5 mm
Plattenbreite 11,0 mm | Abstand zw. d. L. 12,0 mm | Zentraler Steg 30,0 mm

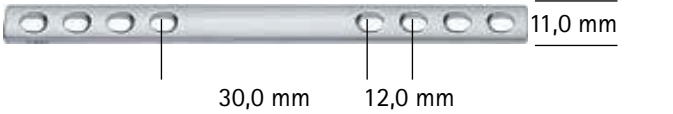
Art-Nr.	Loch	Länge mm	Plattenstärke 3,3 mm
LN950S	8	135	
LN951S	8	145	
LN952S	8	155	
LN953S	8	165	

DCP-Platte | 4,5 mm

Platten für Schraubendurchmesser 4,5 mm
Plattenbreite 12,0 mm | Abstand zw. d. L. 16,0 mm | Zentraler Steg 26,0 mm

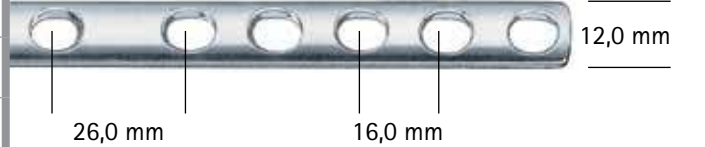
Art-Nr.	Loch	Länge mm	Plattenstärke 4,0 mm
LM404S	4	71	
LM405S	5	87	
LM406S	6	103	
LM407S	7	119	
LM408S	8	135	
LM409S	9	151	
LM410S	10	167	
LM411S	11	183	
LM412S	12	199	
LM414S	14	247	
LM416S	16	263	

Veterinary Cuttable Plates – VCP | 1,5 mm / 2,0 mm

Platten für Schraubendurchmesser 1,5 mm / 2,0 mm
Plattenbreite 5,0 mm / 6,0 mm

Art-Nr.	Loch	Länge mm	Schraube	Plattenstärke	Plattenstärke 1,0 mm / 1,5 mm
VN170S	60	300	1,5	1,0	
VN171S	50	300	2,0	1,5	

Mini Rekonstruktionsplatte | 2,0 mm

Platten für Schraubendurchmesser 2,0 mm
Plattenbreite 5,0 mm | Abstand zw. d. L. 5,0 mm

Art-Nr.	Loch	Länge mm	Plattenstärke 1,2 mm
LN278S	20	100	

Mini Rekonstruktionsplatte | 2,7 mm

Platten für Schraubendurchmesser 2,7 mm
Plattenbreite 8,0 mm | Abstand zw. d. L. 8,0 mm

Art-Nr.	Loch	Länge mm	Plattenstärke 2,7 mm
LN166S	6	48	
LN168S	8	64	
LN170S	10	80	
LN172S	12	96	
LN174S	14	112	
LN176S	16	128	
LN178S	18	144	
LN180S	20	166	

Rekonstruktionsplatte | 3,5 mm

Platten für Schraubendurchmesser 3,5 mm / 4,0 mm
Plattenbreite 10,0 mm | Abstand zw. d. L. 12,0 mm

Art-Nr.	Loch	Länge mm	Plattenstärke 2,5 mm
LN155S	5	58	
LN156S	6	70	
LN157S	7	82	
LN158S	8	94	

1/3 Rohrplatte | 3,5 mm

Platten für Schraubendurchmesser 3,5 mm
Plattenbreite 9,5 mm | Abstand zw. d. L. 12,0 mm | Zentraler Steg 16,0 mm

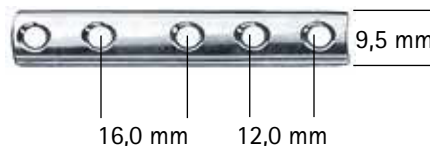
Art-Nr.	Loch	Länge mm	Plattenstärke 1,0 mm
LM304S	4	49	
LM305S	5	61	
LM306S	6	73	
LM307S	7	85	
LM308S	8	97	
LM309S	9	109	
LM310S	10	121	
LM312S	12	145	

Mini Abstützplatte | 2,0 mm

Platten für Schraubendurchmesser 2,0 mm
Plattenbreite Schaft 5,5 mm | Plattenbreite Kopf 10,9 mm

Art-Nr.	Loch	Länge mm	Plattenstärke 1,6 mm
LN903S	2 + 3	24	
LN904S	2 + 4	30	
LN905S	2 + 5	36	
LN906S	2 + 6	42	

Phillips Abstützplatte | 2,0 mm / 2,7 mm

Platten für Schraubendurchmesser 2,0 mm / 2,7 mm
Plattenbreite Schaft 8,1 mm | Plattenbreite Kopf 12,5 mm

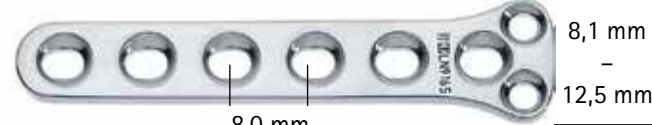
Art-Nr.	Loch	Länge mm	Plattenstärke 2,0 mm
LN914S	2 + 4	36	
LN915S	2 + 5	44	
LN916S	2 + 6	52	

Hybrid Abstützplatte Modell Schuster | 3,5 mm / 2,7 mm

Platten für Schraubendurchmesser 2,7 mm - 3,5 mm
Plattenbreite Schaft 9,2 mm | Plattenbreite Kopf 20,9 mm

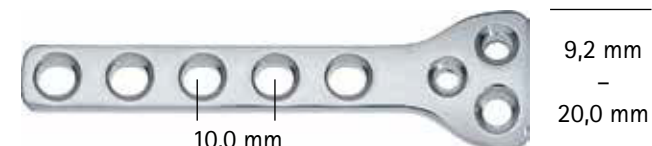
Art-Nr.	Loch	Länge mm	Plattenstärke 3,0 mm
LN923S	3 + 3	50	
LN924S	3 + 4	60	
LN925S	3 + 5	70	
LN926S	3 + 6	80	

Abstützplatte Modell Schuster | 3,5 mm

Platten für Schraubendurchmesser 3,5 mm
Plattenbreite Schaft 9,0 mm | Plattenbreite Kopf 18,2 mm

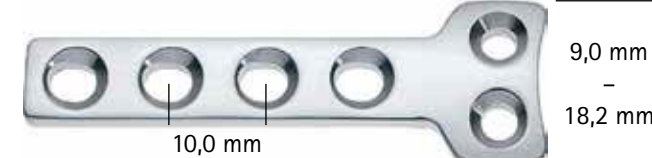
Art-Nr.	Loch	Länge mm	Plattenstärke 3,0 mm
LN934S	2 + 4	55	
LN936S	2 + 6	75	

Abstützplatte Modell Schuster | 3,5 mm

Platten für Schraubendurchmesser 3,5 mm
Plattenbreite Schaft 12,3 mm | Plattenbreite Kopf 21,3 mm

Art-Nr.	Loch	Länge mm	Plattenstärke 3,5 mm
LN986S	2 + 6	83	
LN988S	2 + 8	107	
LN990S	2 + 10	131	

TPLO Platte | 2,7 mm

Platten für Schraubendurchmesser 2,7 mm
Plattenbreite Schaft 8,0 mm | Plattenbreite Kopf xx mm

Art-Nr.	Loch	Länge mm	Seite	Plattenstärke 2,5 mm
LN910S	6	38,8	links	 8,0 mm - 20,7 mm
LN911S	6	38,8	rechts	

TPLO Platte | 3,5 mm

Platten für Schraubendurchmesser 3,5 mm
Plattenbreite Schaft 10,0 mm | Plattenbreite Kopf 27,0 mm

Art-Nr.	Loch	Länge mm	Seite	Plattenstärke 3,0 mm
LN920S	6	51	links	 10,0 mm - 27,0 mm 8,0 mm
LN921S	6	51	rechts	

TPLO Platte breit | 3,5 mm

Platten für Schraubendurchmesser 3,5 mm
Plattenbreite Schaft 12,0 mm | Plattenbreite Kopf 33,0 mm

Art-Nr.	Loch	Länge mm	Seite	Plattenstärke 3,0 mm
LN930S	6	65	links	 12,0 mm - 33,0 mm 8,0 mm
LN931S	6	65	rechts	

Mini Acetabulumplatte Modell Hannover mit Einkerbungen | 2,0 mm

Platten für Schraubendurchmesser 2,0 mm
Plattenbreite 5,0 mm

Art-Nr.	Loch	Länge mm	Plattenstärke 1,5 mm
LN992S	6	31	 5,0 mm

Mini Acetabulumplatte Modell Hannover ohne Einkerbungen | 2,0 mm

Platten für Schraubendurchmesser 2,0 mm
Plattenbreite 5,0 mm

Art-Nr.	Loch	Länge mm	Plattenstärke 1,5 mm
LN993S	6	31	 5,0 mm

Mini Acetabulumplatte Modell Hannover ohne Einkerbungen | 2,7 mm

Platten für Schraubendurchmesser 2,7 mm
Plattenbreite 8,0 mm

Art-Nr.	Loch	Länge mm	Plattenstärke 2,0 mm
LN997S	6	58	 8,0 mm

Acetabulumplatte Modell Hannover mit Einkerbungen | 2,7 mm

Platten für Schraubendurchmesser 2,7 mm
Plattenbreite 8,0 mm

Art-Nr.	Loch	Länge mm	Plattenstärke 2,0 mm
LN994S	4	46	 8,0 mm
LN995S	5	53	
LN996S	6	58	

Mini H-Platte | 1,5 mm / 2,0 mm

Platten für Schraubendurchmesser 1,5 - 2,0 mm
Plattenbreite 7,0 - 13,5 mm

Art-Nr.	Loch	Länge mm	Plattenstärke 1,0 mm
LN030S	4	9,0 x 8,2	
LN040S	4	12,0 x 10,8	

Mini L-Platte links | 2,0 mm

Platten für Schraubendurchmesser 2,0 mm
Plattenbreite 5,0 - 12,0 mm

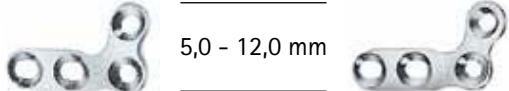
Art-Nr.	Loch	Länge mm	Plattenstärke 1,0 mm
LN221S	4	18	 5,0 - 12,0 mm
LN223S	4	20	

Mini L-Platte rechts | 2,0 mm

Platten für Schraubendurchmesser 2,0 mm
Plattenbreite 5,0 - 12,0 mm

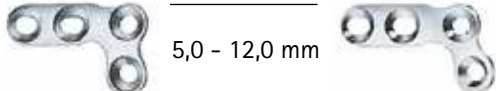
Art-Nr.	Loch	Länge mm	Plattenstärke 1,0 mm
LN222S	4	18	 5,0 - 12,0 mm
LN224S	4	20	

Mini L-Platte links | 2,7 mm

Platten für Schraubendurchmesser 2,7 mm
Plattenbreite 7,0 - 13,5 mm

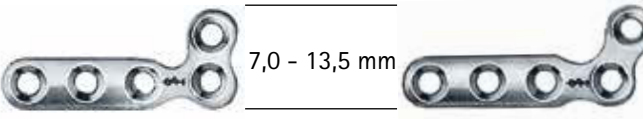
Art-Nr.	Loch	Länge mm	Plattenstärke 1,0 mm
LN021S	5	32	
LN023S	5	34,5	

Mini L-Platte rechts | 2,7 mm

Platten für Schraubendurchmesser 2,7 mm
Plattenbreite 7,0 - 13,5 mm

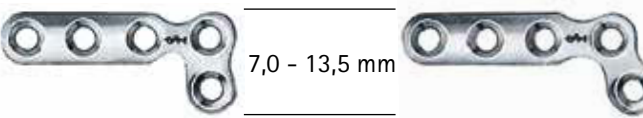
Art-Nr.	Loch	Länge mm	Plattenstärke 1,0 mm
LN022S	5	32	
LN024S	5	34,5	

Mini T-Platte | 2,0 mm

Platten für Schraubendurchmesser 2,0 mm
Plattenbreite 5,0 - 12,0 mm

Art-Nr.	Loch	Länge mm	Plattenstärke 1,0 mm
LN225S	4	18	

Mini T-Platte | 2,7 mm

Platten für Schraubendurchmesser 2,7 mm
Plattenbreite 7,0 - 13,5 mm

Art-Nr.	Loch	Länge mm	Plattenstärke 1,0 mm
LN025S	5	32	

Mehrfragmentplatte | 2,7 mm / 3,5 mm

Platten für Schraubendurchmesser 2,7 mm / 3,5 mm
Plattenbreite 15,0 mm

Art-Nr.	Loch	Länge mm	Plattenstärke 1,2 mm
LN027S	7	45	

Kondylus Platten | 2,0 mm / 2,7 mm / 3,5 mm

Platten für Schraubendurchmesser 2,0 mm / 2,7 mm / 3,5 mm
Plattenbreite Schaft 5,3 mm / 8,0 mm / 12 mm

Art-Nr.	Loch	Länge mm	Plattenstärke 2,0 mm / 2,5 mm / 3,0 mm
VN226S	5 DC + 3	70	
VN227S	5 DC + 3	70	
VN228S	5 DC + 3	90	
VN229S	5 DC + 3	90	
VN230S	5 DC + 3	110	
VN231S	5 DC + 3	110	

Pantarsalarthrodese Hybrid Platten | 2,0 mm - 3,5 mm

Platten für Schraubendurchmesser 2,0 mm - 3,5 mm
Plattenbreite Schaft 5,3 mm - 10 mm

Art-Nr.	Loch	Winkel	Plattenstärke 2,0 mm - 3,0 mm
VN206S	8 DC + 1	120°	
VN206S	8 DC + 1	120°	
VN206S	8 DC + 1	140°	
VN206S	8 DC + 1	140°	
VN206S	8 DC + 1	140°	
VN206S	8 DC + 1	140°	

Pancarpalarthrodese Hybrid Platten | 2,0 mm - 3,5 mm

Platten für Schraubendurchmesser 2,0 mm - 3,5 mm
Plattenbreite Schaft 5,3 mm - 12 mm

Art-Nr.	Loch	Länge mm	Plattenstärke 2,5 mm - 4,0 mm
VN190S	8 DC + 1	75	
VN191S	8 DC + 1	100	
VN193S	8 DC + 1	115	
VN192S	8 DC + 1	140	

Aesculap® Veterinärosteosynthese

Bohrdrähte, Nägel und Cerclagen





mit Trokarspitze
und rundem Ende



mit Trokarspitze
und flachem Ende



mit beidseitiger
Trokarspitze

Kirschner Bohrdrähte

Spitze	Trokar			Trokar		Trokar beidseits	
	rund			flach			
Schaft	Länge			Länge		Länge	
	70	150	310	150	310	150	310
Ø 0,8 mm	LX098S	LX128S		LX108S	LX008S		
Ø 0,9 mm						LX913S	LX917S
Ø 1,0 mm	LX100S	LX130S	LX030S	LX110S	LX010S		
Ø 1,1 mm						LX923S	LX927S
Ø 1,2 mm		LX132S	LX032S	LX112S	LX012S		
Ø 1,4 mm		LX134S	LX034S	LX114S	LX014S		
Ø 1,5 mm		LX135S	LX035S	LX115S	LX015S		
Ø 1,6 mm		LX136S	LX036S	LX116S	LX016S	LX953S	LX957S
Ø 1,7 mm		LX137S		LX117S	LX017S		
Ø 1,8 mm		LX138S	LX038S	LX118S	LX018S		
Ø 2,0 mm		LX140S	LX040S	LX120S	LX020S		
Ø 2,2 mm		LX142S	LX042S	LX122S	LX022S		
Ø 2,5 mm		LX145S	LX045S	LX125S	LX025S		
Ø 3,0 mm		LX146S	LX047S				



ohne Gewinde



mit aufgesetztem Zentralgewinde

Steinmann Nägel

Spitze	Trokar ohne Gewinde			Trokar mit Zentralgewinde		
	Triangular					
Schaft	Ø					
	4,0 mm	4,5 mm	5,0 mm	4,0 mm	4,5 mm	5,0 mm
Länge 100 mm	KX110S					
Länge 150 mm	KX115S	KX225S	KX245S		KX325S	KX345S
Länge 200 mm	KX120S	KX230S	KX250S	KX310S	KX330S	KX350S
Länge 250 mm	KX125S	KX235S	KX255S			KX360S

Cerclagedraht

Ø	Gauge	Länge	Art-Nr.
0,4 mm	27	10 m	KY004S
0,5 mm	25	10 m	KY005S
0,6 mm	23	10 m	KY006S
0,7 mm	22	10 m	KY007S
0,8 mm	21	10 m	KY008S
0,9 mm	20	10 m	KY009S
1,0 mm	19	10 m	KY010S
1,2 mm	18	10 m	KY012S
1,5 mm	17	10 m	KY015S



Ligaturplättchen

KY100S



Aesculap® Veterinärosteosynthese

Bohrer und Gewindeschneider





Bohrer

Ø	Dentalschaft		A0-Schaft		Rundschaft	
	Art-Nr.	Länge mm	Art-Nr.	Länge mm	Art-Nr.	Länge mm
1,1	GC461R	65/28	VC030R	60/35		
	GC481R	38/23				
1,5	GC462R	75/53	VC031R	85/60	GC002R	70/40
	GC482R	38/23				
1,8			VC032R	105/75		
2,0	GC464R	90/58	VC033R	100/75	GC004R	100/50
	GC484R	38/23				
2,4			VC034R	105/75		
2,5			VC035R	110/85	GC006R	100/50
2,7			VC036R	100/75		
3,2			GC319R	150/120	GC009R	100/60
3,5			VC037R	110/85	GC010R	100/60
4,0					GC012R	110/70
4,5			GC323R	150/120	GC013R	150/80
5,0					GC014R	160/90
6,0					GC016R	160/90

DENTALSCHAFT



A0-SCHAFT



RUNDSCHAFT



Schraubendrehereinsätze mit Innensechskant

SW	4 Kant Schaft		A0-Schaft	
	Art-Nr.	Länge mm	Art-Nr.	Länge mm
2,5			GC355R	130
3,5	GC454R	130	GC354R	130

Gewindeschneider

Ø	Dentalschaft		A0-Schaft	
	Art-Nr.	Länge mm	Art-Nr.	Länge mm
1,5	GC437R	50/20	VC040R	130/32
2,0	GC438R	54/24	VC041R	130/32
2,4			VC042R	130/32
2,7			VC043R	130/32
3,5			VC044R	130/50
3,5 spongiosa			GC340R	130/63
4,0			GC346R	130/60
4,5			GC344R	130/63



Kopfraumfräser



Ø	Dentalschaft		A0-Schaft	
	Art-Nr.	Länge mm	Art-Nr.	Länge mm
1,5				
2,0	GC431R	50		
2,4				
2,7				
3,5			GC332R	130
4,5			GC335R	

Aesculap® Veterinärosteosynthese

Osteosyntheseinstrumente



Bohrbüchse für Neutral- und Kompressionsbohrlöcher

VC050R	Einsatz neutral 1,5 mm	für Schrauben 2,0 mm	
VC051R	Einsatz Kompression 1,5 mm		
VC052R	Einsatz neutral 1,8 mm	für Schrauben 2,4 mm	
VC053R	Einsatz Kompression 1,8 mm		
VC054R	Einsatz neutral 2,0 mm	für Schrauben 2,7 mm	
VC055R	Einsatz Kompression 2,0 mm		
VC056R	Einsatz neutral 2,5 mm	für Schrauben 3,5 mm	
VC057R	Einsatz Kompression 2,5 mm		
VC058R	Handgriff für Einsätze VC050R - VC057R		

Gewebeschutzhülse

VC060R	für Bohrer 1,1 mm und 1,5 mm	
VC061R	für Bohrer 1,5 mm und 2,0 mm	
VC062R	für Bohrer 1,8 mm und 2,4 mm	
VC063R	für Bohrer 2,0 mm und 2,7 mm	
VC064R	für Bohrer 2,5 mm und 3,5 mm	

Steckbohrbüchse

	Außen Ø	Bohr Ø	
LS090R	3,5 mm	2,0 mm	
LS097R	3,5 mm	2,7 mm	
LS076S	4,5 mm	3,2 mm	

Zielgerät mit Spitze

LS096R	
--------	--

Biege- und Schränkhebel

VC068R
Biege /Schränkeisen nach Spies
für Platten 2,3 mm – 4,0 mm
220 mm



LS206R/LS207R
Biegeeisen für Platten bis 2,7 mm
140 mm



LS201S
Schränkhebel nach Jewett für
Großfragmentplatten und Marknägel
200 mm



LS202S
Schränkhebel nach Jewett
für Großfragmentplatten und Marknägel
200 mm



LS218R
Schränk- und Biegevorrichtung
für Großfragmentplatten



LS205R
Plattenbiegezange für Minifragmentplatten



LS204
Biegeisen für Minifragmentplatten
120 mm



Biegeschablonen

Art-Nr.	Lochzahl	Länge mm
LS210	5	90
LS212	7	120
LS214	9	150
LS216	12	200
LS220	5	60
LS222	7	85
LS224	9	100
LS226	12	120



Schraubendreher

LS001R
Schraubenzieher für Schrauben 4,5 – 6,5
SW 3,5 mm 200 mm mit Haltefeder



LS003R
Schraubenzieher für Schrauben 4,5 – 6,5
SW 3,5 mm 200 mm



LS002R
Schraubenzieher für Schrauben 2,7 – 4,0
SW 2,5 mm 200 mm



LS005R
Schraubenzieher für Schrauben 1,5 – 2,4
SW 1,5 mm 120 mm



LS007R
Haltehülsen für Schrauben 1,5 – 2,4



LS008R
Haltehülsen für Schrauben 2,7 – 4,5



LS059R
Ausdreher für Schrauben SW 2,5 mm



LS099R
Ausdreher für Schrauben SW 3,5 mm



Handgriffe

FR103R
Handbohrfutter Jacobs Chuck 140 mm
Ø bis 4,5 mm



GC405R
T-Griff mit 4-Kant-Spannfutter





GC407R
Handgriff mit Spannfutter für Dentalschaft





GC475R
T-Griff mit AO-Spannfutter





<p>LX202S T-Griff mit Jacobs Chuck bis 6,5 mm 150 mm</p>	
<p>LX203R T-Griff mit Jacobs Chuck bis 6,5 mm 160 mm</p>	









Haltepinzetten









<p>LS037S Schraubenhaltepinzette 100 mm</p>	
<p>LS040S Schraubenhaltepinzette für kleine Schrauben 90 mm</p>	







Tiefenmesslehre





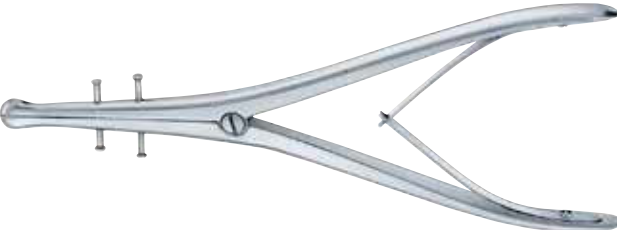

<p>LS042R Tiefenmesslehre 1,5 – 2,4 mm</p>	
<p>LS044R Tiefenmesslehre 2,7 – 4,0 mm</p>	
<p>LS047R Tiefenmesslehre 4,5 – 6,5 mm</p>	

Halte- und Repositionszangen

<p>VC070R Repositionszange mit abgesetzt. Spitzen modifiziert 95 mm</p>	
<p>VC071R Repositionszange modifiziert 135 mm</p>	
<p>VC072R Repositionszange modifiziert 200 mm</p>	
<p>FO116R Repositionszange 170 mm</p>	
<p>FO123R Zange mit Zahnsperre 140 mm</p>	
<p>FO124R Zange mit Gewindesperre 170 mm</p>	
<p>FO125R Zange mit Gewindesperre 235 mm</p>	
<p>FO106R Repositionszange mit Bohrbüchse für Kirschner Drähte bis 1,0 mm 170 mm</p>	

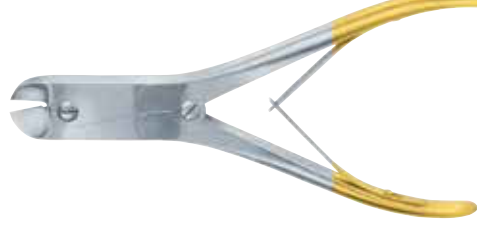

<p>FO169R – FO171R Knochenhaltezange selbstzentrierend mit Gewindesperre 145 mm, 190 mm, 240 mm</p>	
<p>FO180R Knochenhaltezange Verbrugge 175 mm</p>	
<p>FO181R Knochenhaltezange Verbrugge mit Lappenverschluss 255 mm</p>	
<p>FO153R Patellazange 185 mm</p>	
<p>FO412R Hohlmeißelzange Luer</p>	
<p>FO620R Knochensplitterzange nach Liston 140 mm</p>	
<p>Drahtextension</p>	
<p>LX175S Biegeinstrument für Bohrdrähte 120 mm 2,7 mm Durchmesser</p>	
<p>LX180S Biegeinstrument für Bohrdrähte nach Wagner 300 mm 3,0 mm Durchmesser</p>	

<p>KY204R Drahtumführungsnadel 240 mm</p>	
<p>KY205R Drahtumführungsnadel 225 mm</p>	
<p>KY220S Drahtspanner Loute 220 mm</p>	
<p>KY225R Drahtspannzange 270 mm</p>	
<p>BM111R Drahtspannzange 175 mm</p>	
<p>LX172R Drahtfasszange 190 mm</p>	
<p>LX174R Tonnenzange 200 mm</p>	
<p>LX176R Drahtfasszange mit seitlichen Backen</p>	





<p>DP501R Drahtschneidezange bis 1,5 mm</p>	
<p>DP505R Drahtschneidezange bis 1,5 mm</p>	
<p>LX156R Drahtschneidezange bis 3,0 mm</p>	
<p>LX159R Drahtschneidezange bis 2,0 mm</p>	
<p>LX164R Bolzenschneider bis 6,0 mm</p>	
<p>LX165R Bolzenschneider für Nägel bis 3,0 mm</p>	

Hämmer und Meißel

<p>FL036R Hammer mit auswechselbaren Kunststoffbacken 135 g</p>	
<p>FL044R Hammer nach Hajek 135 g</p>	

<p>FL055R Hammer nach Bergmann 245 g</p>												
<p>FL101R – FL109R Osteotome Lambotte 4,0 mm – 15,0 mm Breite 125 mm lang</p>	<table border="1"> <tr> <td>FL101R</td> <td>4 mm</td> </tr> <tr> <td>FL102R</td> <td>6 mm</td> </tr> <tr> <td>FL104R</td> <td>8 mm</td> </tr> <tr> <td>FL106R</td> <td>10 mm</td> </tr> <tr> <td>FL109R</td> <td>15 mm</td> </tr> </table>	FL101R	4 mm	FL102R	6 mm	FL104R	8 mm	FL106R	10 mm	FL109R	15 mm	
FL101R	4 mm											
FL102R	6 mm											
FL104R	8 mm											
FL106R	10 mm											
FL109R	15 mm											
<p>FL441R – FL443R Spongiosa Hohlmeißel Lexer 5,0 mm – 10,0 mm</p>												

Raspatorium

<p>FK317R Raspatorium 185 mm 3,0 mm</p>	
<p>FK318R Raspatorium 190 mm 6,0 mm</p>	
<p>FK319R Raspatorium 190 mm 6,0 mm</p>	
<p>FK321R Raspatorium 190 mm 6,0 mm</p>	
<p>FK323R Raspatorium 175 mm 13,0 mm</p>	

Aesculap® Veterinärosteosynthese

Osteosynthese-Sets

FK324R
Raspatorium 190 mm 14,0 mm



FK300R
Raspatorium Williger 160 mm 6,0 mm



Knochenheber

FK117R
Knochenheber 160 mm 6,0 mm



FK113R
Knochenheber 150 mm 4,5 mm



FK170R
Knochenheber 220 mm 16 mm



FK171R
Knochenheber 240 mm 17 mm



FK188R
Knochenheber 230 mm 43,0 mm



Weitere Instrumente auf Anfrage



Art-Nr.	Anzahl	Name	Loch	Länge mm	Art-Nr.	Anzahl	Name
VN144S	1	DCP-Platte 1,5	4	20	VC070R	1	Repositionszange 95 mm
VN146S	1	DCP-Platte 1,5	6	30	VC071R	2	Repositionszange 135 mm
VN148S	1	DCP-Platte 1,5	8	40	VC050R	1	Neutralbohrbüchse 2,0
VN154S	1	DCP-Platte 2,0	4	22	VC051R	1	Spannbohrbüchse 2,0
VN156S	1	DCP-Platte 2,0	6	32	VC052R	1	Neutralbohrbüchse 2,4
VN158S	1	DCP-Platte 2,0	8	42	VC053R	1	Spannbohrbüchse 2,4
VN160S	1	DCP-Platte 2,0	10	52	VC058R	1	Kompressionsbohrbüchse Griff
VN162S	1	DCP-Platte 2,0	12	62	VC060R	1	Gewebeschutzhülse 1,1/1,5
VN176S	1	DCP-Platte 2,4	6	45	VC061R	1	Gewebeschutzhülse 1,5/2,0
VN178S	1	DCP-Platte 2,4	8	59	VC062R	1	Gewebeschutzhülse 1,8/2,4
VN180S	1	DCP-Platte 2,4	10	73	LS206R	1	Biegeeisen
VN182S	1	DCP-Platte 2,4	12	87	LS207R	1	Biegeeisen
VN184S	1	DCP-Platte 2,4	14	101	VC030R	1	Bohrer AO Schaft 1,1
VB161S	3	Schraube	1,5 mm	6	VC031R	1	Bohrer AO Schaft 1,5
VB162S	3	Schraube	1,5 mm	7	VC032R	1	Bohrer AO Schaft 1,8
VB163S	3	Schraube	1,5 mm	8	VC033R	1	Bohrer AO Schaft 2,0
VB164S	3	Schraube	1,5 mm	9	VC034R	1	Bohrer AO Schaft 2,4
VB165S	3	Schraube	1,5 mm	10	GC437R	1	Gewindeschneider Dentalschaft 1,5
VB166S	3	Schraube	1,5 mm	11	GC438R	1	Gewindeschneider Dentalschaft 2,0
VB167S	3	Schraube	1,5 mm	12	VC042R	1	Gewindeschneider AO Schaft 2,4
VB168S	3	Schraube	1,5 mm	14	GC475R	1	T-Handgriff AO Schaft
VB421S	3	Schraube	2,0 mm	6	GC407R	1	Dentalhandgriff
VB423S	3	Schraube	2,0 mm	8	LS042R	1	Tiefenmesslehre
VB425S	3	Schraube	2,0 mm	10	LS005R	1	Schraubenzieher
VB427S	3	Schraube	2,0 mm	12	LS007R	1	Schraubenhaltehülse
VB428S	3	Schraube	2,0 mm	14	VB408R	1	Schraubenbank
VB429S	3	Schraube	2,0 mm	16	VB410R	1	Lagerung
VB430S	3	Schraube	2,0 mm	18	VB411R	1	Lagerung
VB431S	3	Schraube	2,0 mm	20	JN095	1	Container
VB471S	3	Schraube	2,4 mm	6	JF284200	1	Siebkorb
VB473S	3	Schraube	2,4 mm	8	JG285R	1	Siebkorb mit Deckel
VB475S	3	Schraube	2,4 mm	10	JF148R	2	Minisiebkorb
VB477S	3	Schraube	2,4 mm	12	JK091	2	Filter
VB478S	3	Schraube	2,4 mm	14	JG381800	1	Deckel für Siebkorb
VB479S	3	Schraube	2,4 mm	16			
VB480S	3	Schraube	2,4 mm	18			
VB481S	3	Schraube	2,4 mm	20			
VB482S	3	Schraube	2,4 mm	22			
VB483S	3	Schraube	2,4 mm	24			
VB484S	3	Schraube	2,4 mm	26			
VB485S	3	Schraube	2,4 mm	28			



Osteosynthese-Set Kleinfragmente / Großfragmente | 2,7 mm / 3,5 mm / 3,5 mm breit VB402

Art-Nr.	Anzahl	Name	Loch	Länge mm	Art-Nr.	Anzahl	Name
VN196S	1	DCP-Platte 2,7	6	52	VC054R	1	Neutralbohrbüchse 2,7
VN198S	1	DCP-Platte 2,7	8	68	VC055R	1	Spannbohrbüchse 2,7
VN200S	1	DCP-Platte 2,7	10	84	VC056R	1	Neutralbohrbüchse 3,5
VN202S	1	DCP-Platte 2,7	12	100	VC057R	1	Spannbohrbüchse 3,5
VN218S	1	DCP-Platte 3,5	8	98	VC058R	1	Kompressionsbohrbüchse Griff
VN220S	1	DCP-Platte 3,5	10	122	VC063R	1	Gewebeschutzhülse 2,0/2,7
VN222S	1	DCP-Platte 3,5	12	146	VC064R	1	Gewebeschutzhülse 2,5/3,5
VN238S	1	DCP-Platte 3,5	8	98	VC068R	2	Biegeeisen n. Spies
VN240S	1	DCP-Platte 3,5	10	122	VC033R	1	Bohrer AO Schaft 2,0
VN242S	1	DCP-Platte 3,5	12	146	VC035R	1	Bohrer AO Schaft 2,5
VB533S	3	Schraube	2,7 mm	8	VC036R	1	Bohrer AO Schaft 2,7
VB535S	3	Schraube	2,7 mm	10	VC037R	1	Bohrer AO Schaft 3,5
VB537S	3	Schraube	2,7 mm	12	VC043R	1	Gewindeschneider AO Schaft 2,7
VB538S	3	Schraube	2,7 mm	14	VC044R	1	Gewindeschneider AO Schaft 3,5
VB539S	3	Schraube	2,7 mm	16	VC071R	2	Repositionszange 135 mm
VB540S	3	Schraube	2,7 mm	18	VC072R	1	Repositionszange 205 mm
VB541S	3	Schraube	2,7 mm	20	LS044R	1	Tiefenmesslehre
VB542S	3	Schraube	2,7 mm	22	LS002R	1	Schraubenzieher
VB543S	3	Schraube	2,7 mm	24	LS008R	1	Haltehülse
VB544S	3	Schraube	2,7 mm	26	GC475R	1	T-Handgriff AO Schaft
VB545S	3	Schraube	2,7 mm	28	VB409R	1	Schraubenbank
VB546S	3	Schraube	2,7 mm	30	VB412R	1	Lagerung
VB565S	3	Schraube	3,5 mm	10	VB413R	1	Lagerung
VB567S	3	Schraube	3,5 mm	12	VB414R	1	Lagerung
VB568S	3	Schraube	3,5 mm	14	JN096	1	Container
VB569S	3	Schraube	3,5 mm	16	JF282R	1	Siebkorb
VB570S	3	Schraube	3,5 mm	18	JF289R	1	Deckel Siebkorb
VB571S	3	Schraube	3,5 mm	20	JF148R	1	Minisiebkorb
VB572S	3	Schraube	3,5 mm	22	JK091	2	Filter
VB573S	3	Schraube	3,5 mm	24			
VB574S	3	Schraube	3,5 mm	26			
VB575S	3	Schraube	3,5 mm	28			
VB576S	3	Schraube	3,5 mm	30			
VB577S	3	Schraube	3,5 mm	32			
VB579S	3	Schraube	3,5 mm	36			
VB581S	3	Schraube	3,5 mm	40			

Osteosynthese-Set Kleinfragmente / Großfragmente



Osteosynthese-Set Pins und Cerclagen

VB403

Art-Nr.	Anzahl	Name	Länge mm
VC071R	2	Repositionszange	135
FR103R	1	Handbohrfutter Jacobs Chuck	140
DP505R	1	Drahtschneidezange	160
LX130S	10	Kirschner Draht 1,0 mm	150
LX132S	10	Kirschner Draht 1,2 mm	150
LX135S	10	Kirschner Draht 1,5 mm	150
LX140S	10	Kirschner Draht 2,0 mm	150
KY004S	1	Cerclage 0,4 mm	10 m
KY008S	1	Cerclage 0,8 mm	10 m
KY010S	1	Cerclage 1,0 mm	10 m
JN094	1	Container	
JG386R	1	Siebkorb mit Deckel	
VB415R	1	Lagerung	
JK091	2	Filter	



Sterilcontainer

JN092

Container 313 x 190 x 46
Innenmaß 277 x 176 x 20

JN094

Container 313 x 190 x 65
Innenmaß 277 x 176 x 39

JN095

Container 313 x 190 x 92
Innenmaß 277 x 176 x 66

JN096

Container 313 x 190 x 130
Innenmaß 277 x 176 x 104

JK091

Dauerfilter doppelt verpackt



Siebkörbe

JF148R
Siebkorb für Kleinteile 145 x 44 x 25
Innenmaß 140 x 39 x 18



JG386R
Siebkorb 274 x 172 x 30 mit Deckel
Innenmaß 267 x 170 x 34



JG285R
Siebkorb 274 x 172 x 60 mit Deckel
Innenmaß 258 x 170 x 53



JF264R
Siebkorb 274 x 171 x 42 mit Deckel
Innenmaß 258 x 170 x 34



JF282R
Siebkorb 270 x 171 x 93 ohne Deckel
Innenmaß 267 x 169 x 91



JF289R
Deckel für JF282R



Lagerungshilfen

VB408R
Schraubenbank für 1,5 – 2,0 – 2,4
für JF282R



VB409R
Schraubenbank für 2,7 – 3,5
für JF288R



LX002R
Sortiergestell Kirschnerdrähte bis 150 mm
170 x 92 x 25 mm

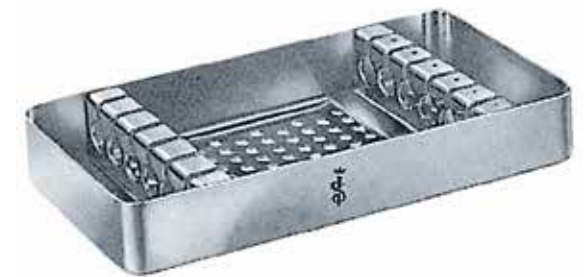

LX001R
Sortiergestell Kirschnerdrähte bis 310 mm
315 x 195 x 60 mm

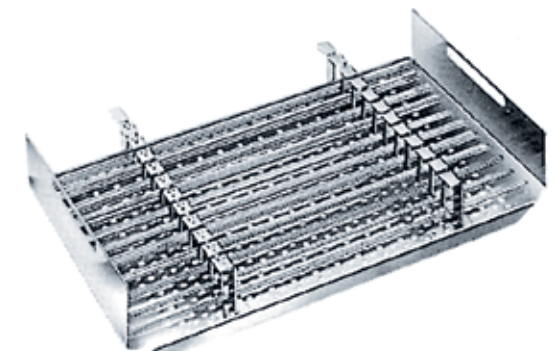

Index

Art.-Nr.	Seite	Art.-Nr.	Seite	Art.-Nr.	Seite	Art.-Nr.	Seite	Art.-Nr.	Seite	Art.-Nr.	Seite	Art.-Nr.	Seite	Art.-Nr.	Seite
BM111R	37	GC454R	7, 26	LA140S	5	LB354S	6	LN906S	15	LS059R	33	LX138S	22	VB480S	4, 42
DP501R	38	GC458R	7	LA142S	5	LB356S	6	LN910S	16	LS076S	30	LX140S	22, 46	VB481S	4, 42
DP505R	38, 46	GC461R	7, 26	LA144S	5	LB358S	6	LN911S	16	LS090R	30	LX142S	22	VB482S	4, 42
FK113R	40	GC462R	7, 26	LA146S	5	LB360S	6	LN914S	15	LS096R	30	LX145S	22	VB483S	4, 42
FK117R	40	GC464R	7, 26	LA148S	5	LB362S	6	LN915S	15	LS097R	30	LX146S	22	VB484S	4, 42
FK170R	40	GC475R	33, 42, 44	LA150S	5	LB364S	6	LN916S	15	LS099R	33	LX156R	38	VB485S	4, 42
FK171R	40	GC481R	7, 26	LA152S	5	LB366S	6	LN920S	16	LS201S	31	LX159R	38	VB486S	4
FK188R	40	GC482R	7, 26	LA154S	5	LB368S	6	LN921S	16	LS202S	31	LX164R	38	VB487S	4
FK300R	40	GC484R	7, 26	LA156S	5	LB370S	6	LN923S	15	LS204	32	LX165R	38	VB488S	4
FK317R	39	JF148R	42, 44, 48	LA158S	5	LB372S	6	LN924S	15	LS205R	31	LX172R	37	VB489S	4
FK318R	39	JF264R	48	LA160S	5	LB375S	6	LN925S	15	LS206R	31, 42	LX174R	37	VB490S	4
FK319R	39	JF282R	44, 48	LA195S	6	LB380S	6	LN926S	15	LS207R	31, 42	LX175S	36	VB491S	4
FK321R	39	JF289R	44, 48	LA197S	6	LB385S	6	LN930S	16	LS210	32	LX176R	37	VB531S	5
FK323R	39	JF284200	42	LA220S	6	LB390S	6	LN931S	16	LS212	32	LX180S	36	VB533S	5, 44
FK324R	40	JG285R	42, 48	LA225S	6	LB395S	6	LN934S	15	LS214	32	LX202S	34	VB535S	5, 44
FO36R	38	JG386R	46, 48	LA230S	6	LB400S	6	LN936S	15	LS216	32	LX203R	34	VB537S	5, 44
FO44R	38	JG381800	42	LA235S	6	LM304S	14	LN939S	10	LS218R	31	LX913S	22	VB538S	5, 44
FO55R	39	JK091	42, 44, 46, 47	LA240S	6	LM305S	14	LN940S	10	LS220	32	LX917S	22	VB539S	5, 44
FL101R	39	JN092	47	LA245S	6	LM306S	14	LN942S	10	LS222	32	LX923S	22	VB540S	5, 44
FL102R	39	JN094	46, 47	LA250S	6	LM307S	14	LN944S	10	LS224	32	LX927S	22	VB541S	5, 44
FL104R	39	JN095	42, 47	LA255S	6	LM308S	14	LN946S	10	LS226	32	LX953S	22	VB542S	5, 44
FL106R	39	JN096	44, 47	LA260S	6	LM309S	14	LN948S	10	LX001R	49	LX957S	22	VB543S	5, 44
FL109R	39	KX110S	23	LA265S	6	LM310S	14	LN950S	13	LX002R	49	VB161S	4, 42	VB544S	5, 44
FL441R	39	KX115S	23	LA270S	6	LM312S	14	LN951S	13	LX008S	22	VB162S	4, 42	VB545S	5, 44
FL443R	39	KX120S	23	LA280S	6	LM404S	13	LN952S	13	LX010S	22	VB163S	4, 42	VB546S	5, 44
FO106R	35	KX125S	23	LB050S	6	LM405S	13	LN953S	13	LX012S	22	VB164S	4, 42	VB547S	5
FO116R	35	KX230S	23	LB052S	6	LM406S	13	LN956S	11	LX014S	22	VB165S	4, 42	VB548S	5
FO123R	35	KX235S	23	LB054S	6	LM407S	13	LN957S	11	LX015S	22	VB166S	4, 42	VB549S	5
FO124R	35	KX245S	23	LB056S	6	LM408S	13	LN959S	11	LX016S	22	VB167S	4, 42	VB550S	5
FO125R	35	KX250S	23	LB057S	6	LM409S	13	LN960S	11	LX017S	22	VB168S	4, 42	VB551S	5
FO153R	36	KX255S	23	LB058S	6	LM410S	13	LN962S	11	LX018S	22	VB169S	4	VB563S	5
FO169R	36	KX310S	23	LB059S	6	LM411S	13	LN964S	11	LX020S	22	VB170S	4	VB564S	5
FO171R	36	KX325S	23	LB060S	6	LM412S	13	LN966S	11	LX022S	22	VB171S	4	VB565S	5, 44
FO180R	36	KX330S	23	LB061S	6	LM414S	13	LN968S	11	LX025S	22	VB408R	42, 49	VB567S	5, 44
FO181R	36	KX345S	23	LB062S	6	LM416S	13	LN972S	11	LX030S	22	VB409R	44, 49	VB568S	5, 44
FO412R	36	KX350S	23	LB063S	6	LN021S	18	LN973S	11	LX032S	22	VB410R	42	VB569S	5, 44
FO620R	36	KX360S	23	LB064S	6	LN022S	18	LN974S	11	LX034S	22	VB411R	42	VB570S	5, 44
FR103R	33, 46	KY004S	23, 46	LB065S	6	LN023S	18	LN975S	12	LX035S	22	VB412R	44	VB571S	5, 44
GC002R	7, 26	KY005S	23	LB066S	6	LN024S	18	LN976S	12	LX036S	22	VB413R	44	VB572S	5, 44
GC004R	7, 26	KY006S	23	LB067S	6	LN025S	18	LN977S	12	LX038S	22	VB414R	44	VB573S	5, 44
GC006R	7, 26	KY007S	23	LB068S	6	LN027S	18	LN980S	12	LX040S	22	VB415R	46	VB574S	5, 44
GC007R	7	KY008S	23, 46	LB070S	6	LN030S	17	LN981S	12	LX042S	22	VB421S	4, 42	VB575S	5, 44
GC009R	7, 26	KY009S	23	LB072S	6	LN040S	17	LN983S	12	LX045S	22	VB423S	4, 42	VB576S	5, 44
GC010R	7, 26	KY010S	23, 46	LB076S	6	LN155S	14	LN984S	12	LX047S	22	VB425S	4, 42	VB577S	5, 44
GC012R	7, 26	KY012S	23	LB080S	6	LN156S	14	LN986S	15	LX098S	22	VB427S	4, 42	VB579S	5, 44
GC013R	7, 26	KY015S	23	LB250S	6	LN157S	14	LN988S	15	LX100S	22	VB428S	4, 42	VB581S	5, 44
GC014R	26	KY100S	23	LB252S	6	LN158S	14	LN990S	15	LX108S	22	VB429S	4, 42	VB583S	5
GC016R	26	KY204R	37	LB254S	6	LN166S	14	LN992S	16	LX110S	22	VB430S	4, 42	VC030R	7, 26, 42
GC319R	7, 26	KY205R	37	LB256S	6	LN168S	14	LN993S	16	LX112S	22	VB431S	4, 42	VC031R	7, 26, 42
GC323R	7, 26	KY220S	37	LB258S	6	LN170S	14	LN994S	17	LX114S	22	VB432S	4	VC032R	7, 26, 42
GC332R	7, 27	KY225R	37	LB260S	6	LN172S	14	LN995S	17	LX115S	22	VB433S	4	VC033R	7, 26, 42, 44
GC335R	7, 27	LA114S	5	LB262S	6	LN174S	14	LN996S	17	LX116S	22	VB434S	4	VC034R	7, 26, 42
GC340R	7, 27	LA116S	5	LB264S	6	LN176S	14	LN997S	17	LX117S	22	VB435S	4	VC035R	7, 26, 44
GC344R	7, 27	LA118S	5	LB266S	6	LN178S	14	LS001R	7, 32	LX118S	22	VB436S	4	VC036R	7, 26, 44
GC346R	7, 27	LA120S	5	LB268S	6	LN180S	14	LS002R	7, 32, 44	LX120S	22	VB437S	4	VC037R	7, 26, 44
GC354R	7, 26	LA122S	5	LB270S	6	LN221S	17	LS003R	7, 32	LX122S	22	VB438S	4	VC040R	7, 27
GC355R	7, 26	LA124S	5	LB275S	6	LN222S	17	LS005R	7, 32, 42	LX125S	22	VB439S	4	VC041R	7, 27
GC355R	26	LA126S	5	LB280S	6	LN223S	17	LS007R	32, 42	LX128S	22	VB440S	4	VC042R	7, 27, 42
GC405R	33	LA128S	5	LB285S	6	LN224S	17	LS008R	33, 44	LX130S	22, 46	VB471S	4, 42	VC043R	7, 27, 44
GC407R	33, 42	LA130S	5	LB290S	6	LN225S	18	LS037S	34	LX132S	22, 46	VB473S	4, 42	VC044R	7, 27, 44
GC431R	7, 27	LA132S	5	LB295S	6	LN278S	14	LS040S	34	LX134S	22	VB475S	4, 42	VC050R	30, 42
GC437R	7, 27, 42	LA134S	5	LB300S	6	LN903S	15	LS042R	7, 34, 42	LX135S	22, 46	VB477S	4, 42	VC051R	30, 42
GC438R	7, 27, 42	LA136S	5	LB350S	6	LN904S	15	LS044R	7, 34, 44	LX136S	22	VB478S	4, 42	VC052R	30, 42
GC440R	7, 27	LA138S	5	LB352S	6	LN905S	15	LS047R	7, 34	LX137S	22	VB479S	4, 42	VC053R	30, 42

Index

Art.-Nr.	Seite	Art.-Nr.	Seite	Art.-Nr.	Seite	Art.-Nr.	Seite	Art.-Nr.	Seite
VC054R	30, 44	VC538S	5	VN185S	11				
VC055R	30, 44	VC539S	5	VN186S	11				
VC056R	30, 44	VC540S	5	VN190S	19				
VC057R	30, 44	VC541S	5	VN191S	19				
VC058R	30, 42, 44	VC542S	5	VN192S	19				
VC060R	30, 42	VC543S	5	VN193S	19				
VC061R	30, 42	VC544S	5	VN194S	12				
VC062R	30, 42	VC545S	5	VN195S	12				
VC063R	30, 44	VC546S	5	VN196S	12, 42				
VC064R	30, 44	VC547S	5	VN197S	12				
VC068R	31, 44	VC548S	5	VN198S	12, 42				
VC070R	35, 42	VC549S	5	VN199S	12				
VC071R	35, 42, 44, 46	VC550S	5	VN200S	12, 44				
VC072R	35, 44	VC551S	5	VN201S	12				
VC161S	4	VC563S	5	VN202S	12, 42				
VC162S	4	VC564S	5	VN203S	12				
VC163S	4	VC565S	5	VN204S	12				
VC164S	4	VC567S	5	VN206S	19				
VC165S	4	VC568S	5	VN214S	12				
VC166S	4	VC569S	5	VN215S	12				
VC167S	4	VC570S	5	VN216S	12				
VC168S	4	VC571S	5	VN217S	12				
VC169S	4	VC572S	5	VN218S	12, 44				
VC170S	4	VC573S	5	VN219S	12				
VC171S	4	VC574S	5	VN220S	12, 44				
VC421S	4	VC575S	5	VN221S	12				
VC423S	4	VC576S	5	VN222S	12, 44				
VC425S	4	VC577S	5	VN224S	12				
VC427S	4	VC579S	5	VN226S	19				
VC428S	4	VC581S	5	VN227S	19				
VC429S	4	VC583S	5	VN228S	19				
VC430S	4	VN144S	10, 42	VN229S	19				
VC431S	4	VN145S	10	VN230S	19				
VC432S	4	VN146S	10, 42	VN231S	19				
VC433S	4	VN147S	10	VN236S	13				
VC434S	4	VN148S	10, 42	VN237S	13				
VC435S	4	VN154S	10, 42	VN238S	13, 44				
VC436S	4	VN155S	10	VN239S	13				
VC437S	4	VN156S	10, 42	VN240S	13, 44				
VC438S	4	VN157S	10	VN241S	13				
VC439S	4	VN158S	10, 42	VN242S	13, 44				
VC440S	4	VN159S	10	VN244S	13				
VC471S	4	VN160S	10, 42						
VC473S	4	VN161S	10						
VC475S	4	VN162S	10, 42						
VC477S	4	VN163S	10						
VC478S	4	VN164S	10						
VC479S	4	VN165S	10						
VC480S	4	VN166S	10						
VC481S	4	VN167S	10						
VC482S	4	VN168S	10						
VC483S	4	VN170S	14						
VC484S	4	VN171S	14						
VC485S	4	VN174S	11						
VC486S	4	VN175S	11						
VC487S	4	VN176S	11, 42						
VC488S	4	VN177S	11						
VC489S	4	VN178S	11, 42						
VC490S	4	VN179S	11						
VC491S	4	VN180S	11, 42						
VC531S	5	VN181S	11						
VC533S	5	VN182S	11, 42						
VC535S	5	VN183S	11						
VC537S	5	VN184S	11, 42						

B. Braun Vet Care GmbH | Am Aesculap-Platz | 78532 Tuttlingen
Fax +49 (0) 74 61 715 12 | info@bbraun-vetcare.de | www.bbraun-vetcare.de

Aesculap – a B. Braun company

Die Hauptproduktmarke Aesculap ist eine eingetragene Marke der Aesculap AG.

Technische Änderungen vorbehalten. Dieser Prospekt darf ausschließlich zur Information über unsere Erzeugnisse verwendet werden. Nachdruck, auch auszugsweise, verboten.

Prospekt Nr. V08701

0315/1.0/4